

## YDS-P4MA-IMX219 V1.4

### 8MP Sony IMX219 MIPI Interface Auto Focus Camera Module



Front View



Back View

#### Specifications

Camera Module No.	YDS-P4MA-IMX219 V1.4
Resolution	8MP
Image Sensor	IMX219
Sensor Type	1/4"
Pixel Size	1.12 um x 1.12 um
EFL	5.54 mm
F.NO	2.40
Pixel	3296 x 2480
View Angle	44.6°(DFOV) 36.4°(HFOV) 27.8°(VFOV)
Lens Dimensions	8.50 x 8.50 x 5.93 mm
Module Size	31.90 x 9.80 mm
Module Type	Auto Focus
Interface	MIPI
Auto Focus VCM Driver IC	DW9714P
Lens Model	YDS-LENS-50190A5
Lens Type	650nm IR Cut
Operating Temperature	-20°C to +60°C
Mating Connector	24-5804-030-000-829



## YDS-P4MA-IMX219 V1.4 8MP Sony IMX219 MIPI Interface Auto Focus Camera Module



Top View



Side View

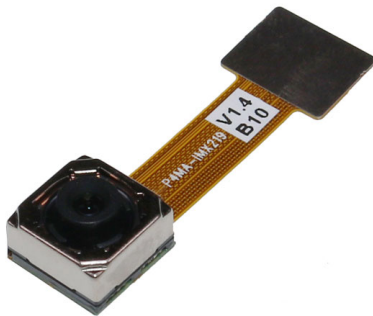

Bottom View

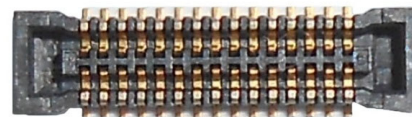

Mating Connector

Version	Information	Date
V1.0	First Version	10-9-2019
V1.4	Change lens and VCM	10-23-2021

ROHS	
1	GND
2	AF-VDD2. 8V
3	DVDD1. 2V
4	DOVDD1. 8V
5	NC
6	AVDD GND
7	AVDD2. 8V
8	DGND
9	I2C-SDA
10	I2C-SCL
11	NC
12	PWDN1
13	GND
14	MCLK
15	GND
16	DP3
17	DN3
18	GND
19	DP2
20	DN2
21	GND
22	DP1
23	DN1
24	GND
25	CLKP
26	CLKN
27	GND
28	DPO
29	DNO
30	GND

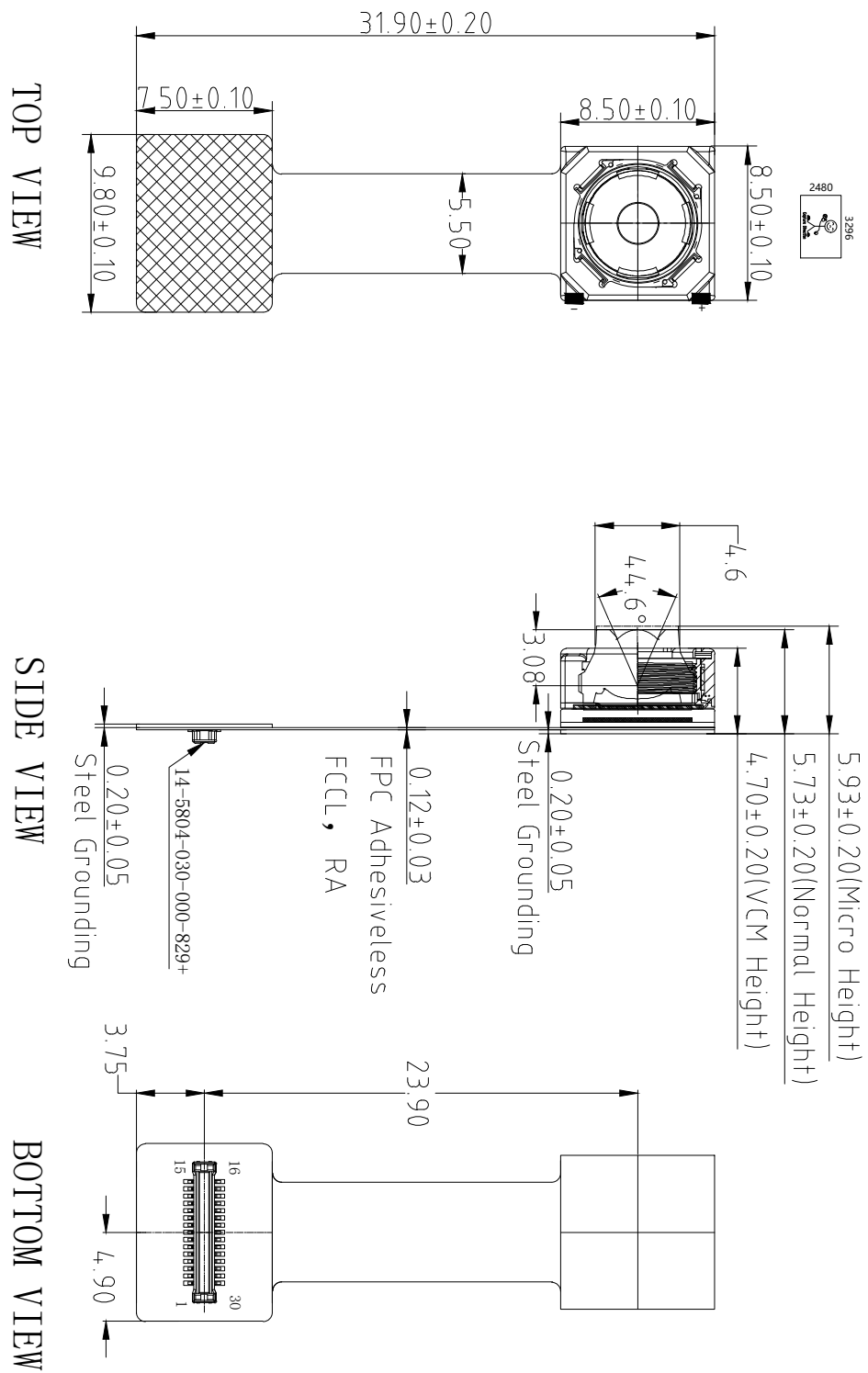

**Parameters:**

**1、Sensor specification:**

Image Sensor: IMX219  
 Pixel: 1.2um×1.2um  
 Lens Type: 1/4  
 Important Voltage Description: DVDD1.2V (external power supply);

**2、Lens specification:**

FOV: 44.6°(D);36.4°(H);27.8°(V)  
 F/NO.: 2.4  
 TV distortion: <1.5%  
 Focal length: 5.54mm  
 Composition: 5P+IR FILTER  
 IR Cut Coating: 650nm±10nm@50%

Designed By	Kevin	Model Name:	P4MA-IMX219 V1.4	
Checked By	Aouly__Yan	Projection Type:	Unit: mm	Material: -----
		Third Angle	Scale: 1:1	Sheet: 1 of 1
				Version: 1/0

## [Product Brief]

Ver.1.0

# IMX219PQ

Diagonal 4.60mm (Type 1/4.0) 8M Pixel CMOS Image Sensor with Square Pixel for Color Cameras

---

### Description

IMX219PQ is a diagonal 4.60mm (Type 1/4.0) CMOS active pixel type image sensor with a square pixel array and 8.08M effective pixels. This chip operates with three power supplies, analogue 2.8V, digital 1.2 V, and IF 1.8 V, and has low power consumption. High sensitivity, low dark current, and no smear are achieved through the adoption of R, G, and B primary color pigment mosaic filters. This chip features an electronic shutter with variable charge-storage time.

In addition, this product is designed for use in cellular phone and tablet pc. When using this for another application, Sony does not guarantee the quality and reliability of product. Therefore, don't use this for applications other than cellular phone and tablet pc. Consult your Sony sales representative if you have any questions.

---

### Functions and Features

- ◆ Back-illuminated CMOS image sensor Exmor R™
- ◆ 2-wire serial communication circuit on chip
- ◆ CSI2 serial data output (selection of 4lane/2lane)
- ◆ Timing generator, H and V driver circuits on chip
- ◆ CDS/PGA on chip
- ◆ 10-bit A/D converter on chip
- ◆ Automatic optical black (OB) clamp circuit on chip
- ◆ PLL on chip (rectangular wave)
- ◆ High sensitivity, low dark current, no smear
- ◆ Excellent anti-blooming characteristics
- ◆ Variable-speed shutter function (1 H units)
- ◆ R, G, B primary color pigment mosaic filters on chip
- ◆ Max. 30frame/s in all-pixel scan mode
- ◆ Pixel rate: 280 [Mpixel/s] (All-pixels mode)
- ◆ 180 frame/s @720p with 2x2 analog (special) binning, 60 frame/s @1080p with V-crop
- ◆ Datarate: Max.755Mbps/lane (@4lane), 912Mbps/Lane(@2lane)

**Device Structure**

- ◆ CMOS image sensor
- ◆ Image size : Diagonal 4.60mm (Type 1/4.0)
- ◆ Total number of pixels : 3296(H) × 2512(V) approx. 8.28M pixels
- ◆ Number of effective pixels : 3296(H) × 2480(V) approx. 8.17M pixels
- ◆ Number of active pixels : 3280(H) × 2464(V) approx. 8.08M pixels
- ◆ Chip size : 5.095mm (H) × 4.930mm (V) (w/ Scribe)
- ◆ Unit cell size : 1.12µm (H) × 1.12µm (V)
- ◆ Substrate material : Silicon

**Functional Description**

**Block diagram**

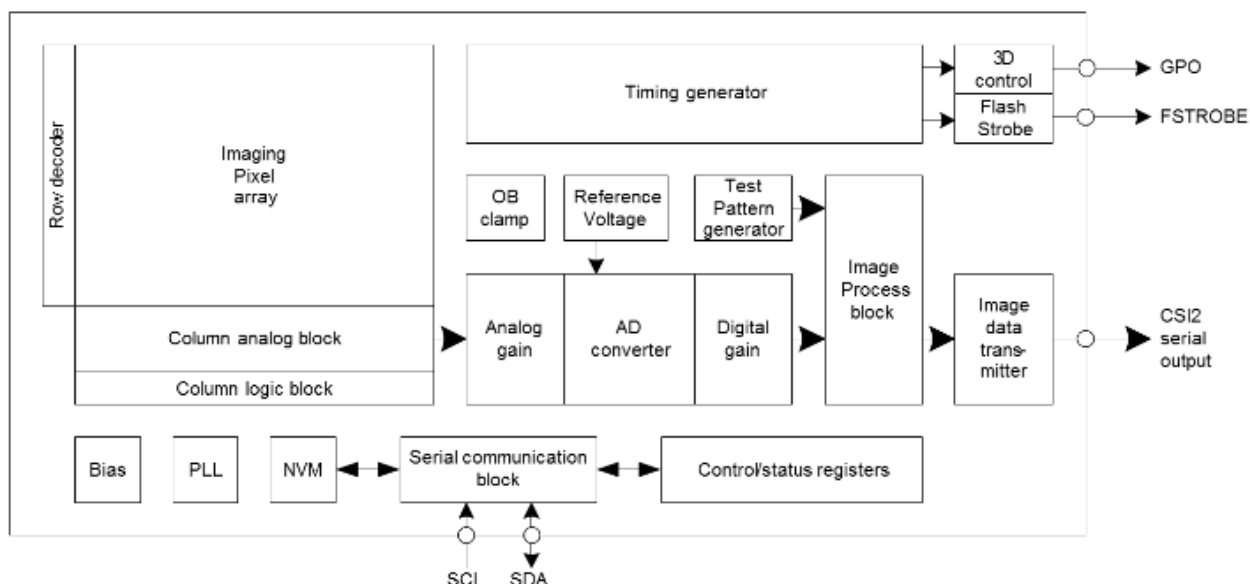

**Exmor R**

\* Exmor R is a trademark of Sony Corporation. The Exmor R is a Sony's CMOS image sensor with significantly enhanced imaging characteristics including sensitivity and low noise by changing fundamental structure of Exmor™ pixel adopted column parallel A/D converter to back-illuminated type.

Sony reserves the right to change products and specifications without prior notice.  
 This information does not convey any license by any implication or otherwise under any patents or other right.  
 Application circuits shown, if any, are typical examples illustrating the operation of the devices. Sony cannot assume responsibility for any problems arising out of the use of these circuits.

**FEATURES**

- 120mA output driver with 10-bit resolution DAC
- Smart Actuator Control (SAC™) modes
- Supply voltage ( $V_{DD}$ ): 2.3V to 4.3V
- I/O voltage ( $V_{IN}$ ): 1.8V to  $V_{DD}$
- Fast mode and Fast mode plus I<sup>2</sup>C interface compatible
- Power On Reset (POR)
- Power Down (PD) mode current consumption less than 1uA
- Package: 6-pin WLCSP (0.77mm x 1.14mm x 0.30mm)

**APPLICATIONS**

- Mobile camera
- Digital still camera
- Camcorder
- Web camera
- Action camera

**GENERAL DESCRIPTION**

The DW9714P designed for linear control of Voice Coil Motors (VCM). This device is compatible with DW9714. The DW9714P has a single 10-bit DAC with 120mA output current sink capability. This device features SAC™ mode which can minimize the mechanical vibration and achieve very fast mechanical settling time. The SAC™ is protected by patent and registered trademark of DONGWOON ANATECH.

The DW9714P operates from a single 2.3V to 4.3V supply. The internal DAC is controlled via an I<sup>2</sup>C serial interface that operates at clock rate up to 1MHz. The I<sup>2</sup>C address for the DW9714P is 0x18. The DW9714P offers PD mode with current consumption less than 1uA.

The DW9714P can be used for auto focus applications in mobile cameras, digital still cameras, camcorders, web cameras and action cameras.

**TYPICAL APPLICATION CIRCUIT**

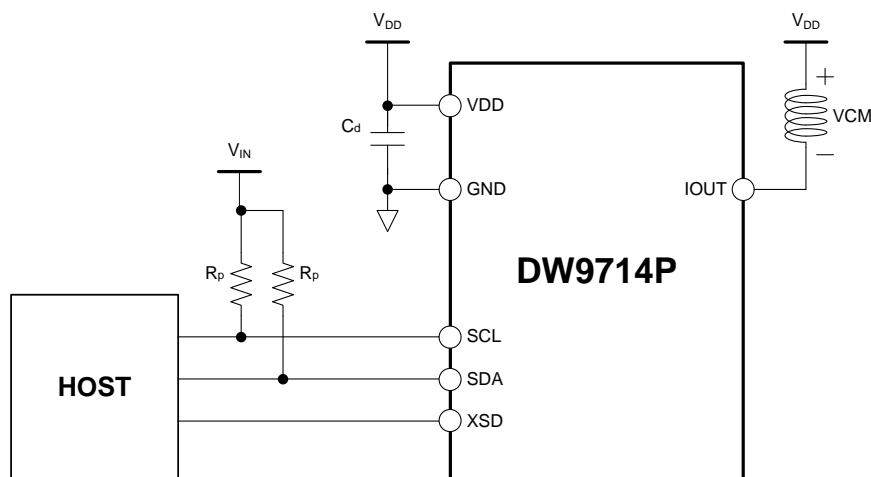

*Figure 1. Typical application circuit*

## YDS-LENS-50190A5

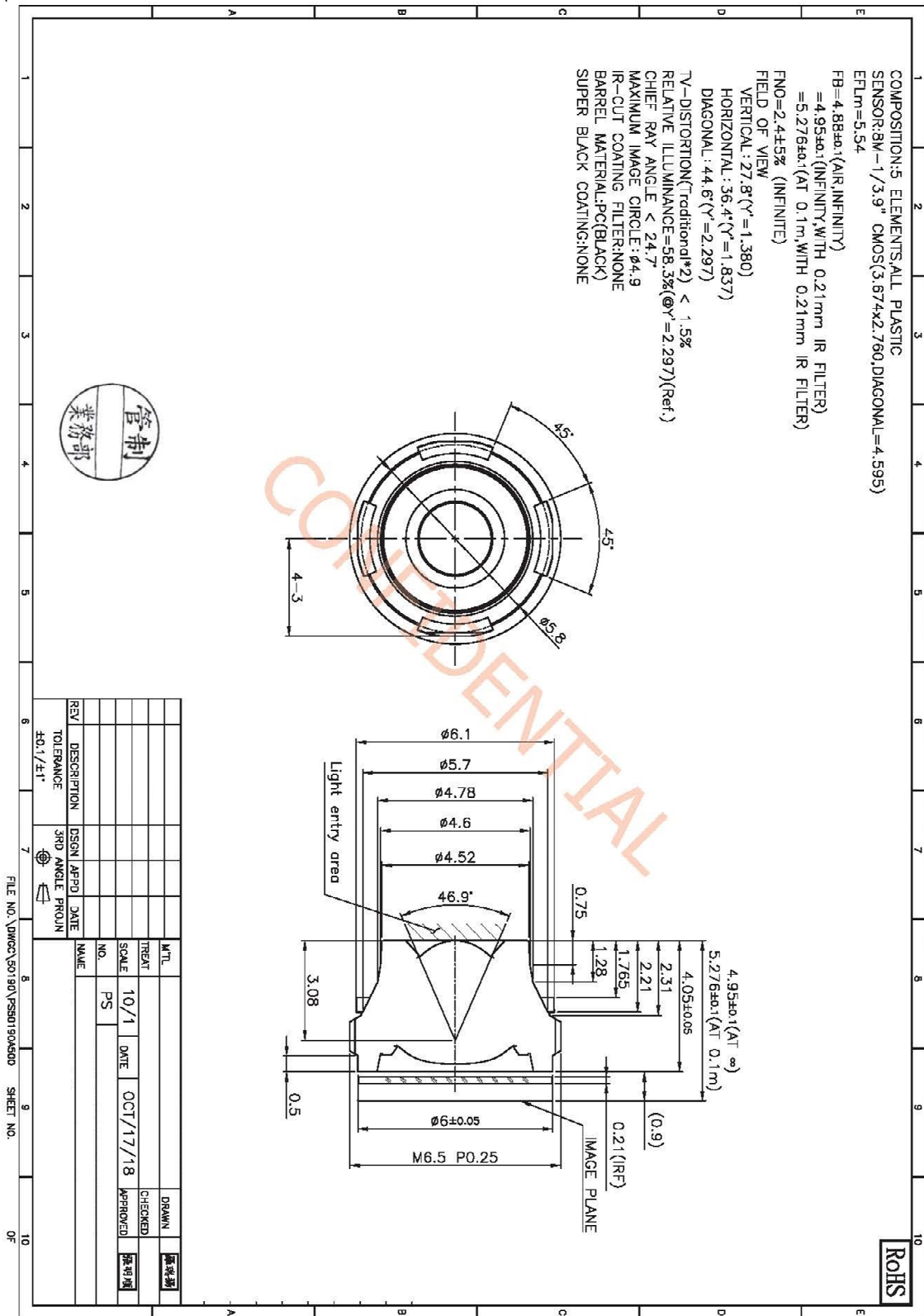

# 0.4<sub>mm</sub>Pitch

# Series 5804

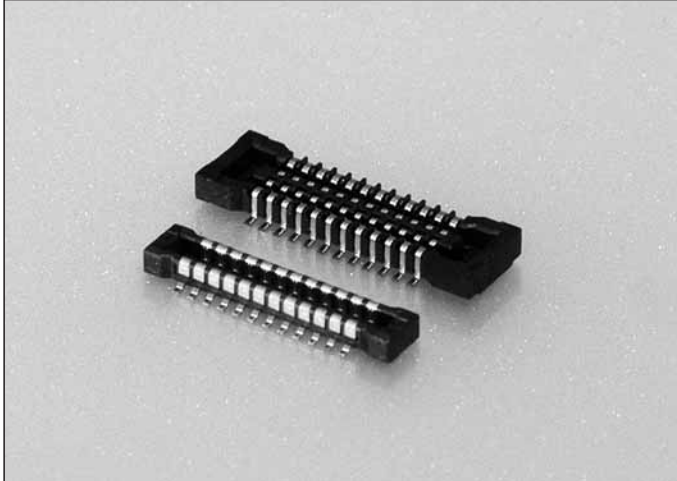

シリーズ (Series)	5804
基板間高さ (Stacking Height)	0.9mm
極間隔 (Pitch)	0.4mm
極数 (No. of Positions)	10~80
定格電流 (Rated Current)	DC 0.3A
定格電圧 (Rated Voltage)	DC 50V
耐電圧 (D.W.Voltage)	AC 250Vrms/min.
コンタクト材質 (Contact Material)	銅合金 Copper alloy
インシュレータ材質 (Insulator Material)	耐熱樹脂 Heat resistance plastic
使用温度範囲 (Operating Temperature)	-40~85°C

## SERIES 5804

### ◇概要

5804シリーズは、市場における携帯電話やデジタルAV機器等の小型化、薄型化の要求に基づき開発された0.4mmピッチ、嵌合高さ0.9mmの超低背基板対基板コネクタです。幅寸法は2.4mmと、より一層の省面積化を実現しています。

### ◇Outline

Series 5804 is a 0.4mm pitch and ultra low profile Board to Board connector with 0.9mm in mating height is developed to meet marketing needs for minimum size of cell phones, digital AV equipment, etc. A great deal of space saving is achieved with 2.4mm in width.

### ◇特長

- (1) スリム・低背でありながらコネクタ裏面に下壁を設け金属の露出がなく、製品の端子ランド対向間にパターン配線が可能であり、高密度実装に最適な構造です。
- (2) 高い接触信頼性を実現するために、接触構造は振動や落下衝撃に強い挟み込み構造を採用するとともに、接触部は飛散したフラックスや付着した異物を排除する独自の構造を採用しました。
- (3) 嵌合時のロック構造は、独自のロック構造を採用。低背でありながらも優れたクリック感と、抜去時の保持力を強化しています。

### ◇Features

- (1) Pattern can be laid out between connector leads, which is suitable for high density package, because no metal is exposed on the bottom of the connector besides its slim and low profile.
- (2) The pinching structure, highly resistant to vibration and drop shock, is adopted in contacts and the original structure excluding splashed flux or foreign matters attached is adopted on contacting points in order to obtain high contacting reliability.
- (3) Original locking structure is adopted for mating lock mechanism that realizes the firm clicking response and enhances the retention force when connectors unmated even with their low profile.

本カタログには推奨めっきを掲載しております。めっき種類・仕様、ならびに生産対応可能極数については営業部に御確認願います。  
Recommended plating types are mentioned in this catalogue.  
For other plating types and their specifications, and available numbers of positions, please feel free to contact our sales department.



0.4mm Pitch  
SERIES

# 5804 プラグ/リセ ST SMT Plug/Receptacle Vertical SMT

## ● Plug

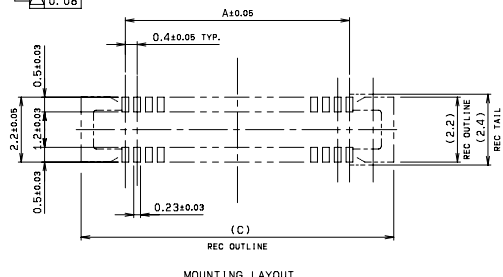
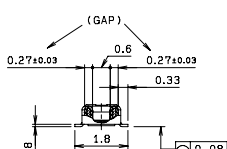
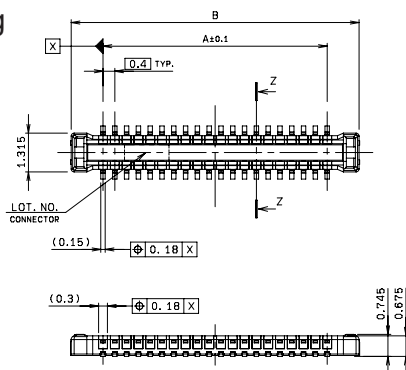

極数 NO. OF POS.	A	B	C
10	1.6	3.76	4.6
12	2.0	4.16	5.0
14	2.4	4.56	5.4
16	2.8	4.96	5.8
18	3.2	5.36	6.2
20	3.6	5.76	6.6
22	4.0	6.16	7.0
24	4.4	6.56	7.4
26	4.8	6.96	7.8
30	5.6	7.76	8.6
32	6.0	8.16	9.0
34	6.4	8.56	9.4
40	7.6	9.76	10.6
44	8.4	10.56	11.4
50	9.6	11.76	12.6
54	10.4	12.56	13.4
60	11.6	13.76	14.6
70	13.6	15.76	16.6
80	15.6	17.76	18.6

## ● Receptacle

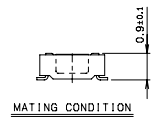
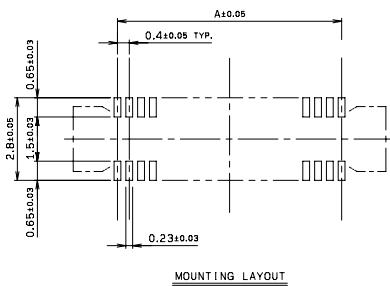
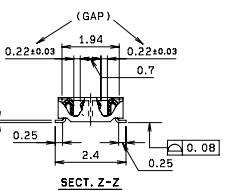
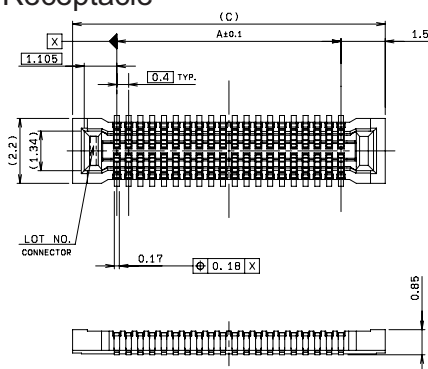

極数 NO. OF POS.	A	C
10	1.6	4.6
12	2.0	5.0
14	2.4	5.4
16	2.8	5.8
18	3.2	6.2
20	3.6	6.6
22	4.0	7.0
24	4.4	7.4
26	4.8	7.8
30	5.6	8.6
32	6.0	9.0
34	6.4	9.4
40	7.6	10.6
44	8.4	11.4
50	9.6	12.6
54	10.4	13.4
60	11.6	14.6
70	13.6	16.6
80	15.6	18.6

## ● Packaging

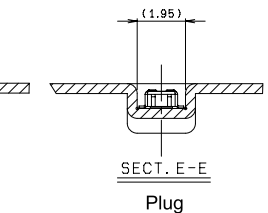
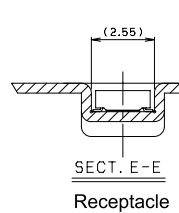
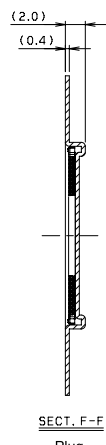
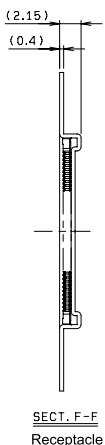
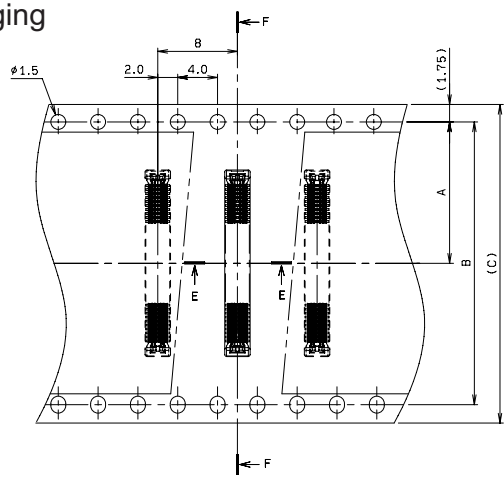

極数 NO. OF POS.	A	B	C
10	5.5	-	12.0
12	5.5	-	12.0
14	7.5	-	16.0
16	7.5	-	16.0
18	7.5	-	16.0
20	7.5	-	16.0
22	7.5	-	16.0
24	7.5	-	16.0
26	7.5	-	16.0
30	7.5	-	16.0
32	7.5	-	16.0
34	11.5	-	24.0
40	11.5	-	24.0
44	11.5	-	24.0
50	11.5	-	24.0
54	11.5	-	24.0
64	11.5	-	24.0
70	11.5	-	24.0
80	14.2	28.4	32.0

注文コード ORDERING CODE  
**X4 5804 0XX 000 829+**

RoHS 対応品  
RoHS Compliant Product

1 : Plug  
2 : Receptacle  
極数 Number of positions

注) 生産可能極数については営業部にご確認願います。  
Note) Feel free to contact our sales department for available numbers of positions.

梱包数量 : 3000個/リール  
PACKING QUANTITY : 3000/Reel



# YDS CAMERA MODULE

*your best camera partner*

## Camera Module Pinout Definition Reference Chart

OmniVision	Sony	Samsung	On-Semi	Aptina	Himax	GalaxyCore	PixArt	SmartSens	Sensors
Pin Signal		Description							
DGND GND		ground for digital circuit							
AGND		ground for analog circuit							
PCLK DCK		DVP PCLK output							
XCLR PWDN XSHUTDOWN STANDBY		power down active high with internal pull-down resistor							
MCLK XVCLK XCLK INCK		system input clock							
RESET RST		reset active low with internal pull-up resistor							
NC NULL		no connect							
SDA SIO_D SIOD		SCCB data							
SCL SIO_C SIOC		SCCB input clock							
VSYNC XVS FSYNC		DVP VSYNC output							
HREF XHS		DVP HREF output							
DOVDD		power for I/O circuit							
AFVDD		power for VCM circuit							
AVDD		power for analog circuit							
DVDD		power for digital circuit							
STROBE FSTROBE		strobe output							
FSIN		synchronize the VSYNC signal from the other sensor							
SID		SCCB last bit ID input							
ILPWM		mechanical shutter output indicator							
FREQ		frame exposure / mechanical shutter							
GPIO		general purpose inputs							
SLASEL		I2C slave address select							
AFEN		CEN chip enable active high on VCM driver IC							
<b>MIPI Interface</b>									
MDN0 DN0 MD0N DATA_N DMO1N		MIPI 1st data lane negative output							
MDP0 DP0 MD0P DATA_P DMO1P		MIPI 1st data lane positive output							
MDN1 DN1 MD1N DATA2_N DMO2N		MIPI 2nd data lane negative output							
MDP1 DP1 MD1P DATA2_P DMO2P		MIPI 2nd data lane positive output							
MDN2 DN2 MD2N DATA3_N DMO3N		MIPI 3rd data lane negative output							
MDP2 DP2 MD2P DATA3_P DMO3P		MIPI 3rd data lane positive output							
MDN3 DN3 MD3N DATA4_N DMO4N		MIPI 4th data lane negative output							
MDP3 DP3 MD3P DATA4_P DMO4P		MIPI 4th data lane positive output							
MCN CLKN CLK_N DCKN		MIPI clock negative output							
MCP CLKP MCP CLK_P DCKN		MIPI clock positive output							
<b>DVP Parallel Interface</b>									
D0 DO0 Y0		DVP data output port 0							
D1 DO1 Y1		DVP data output port 1							
D2 DO2 Y2		DVP data output port 2							
D3 DO3 Y3		DVP data output port 3							
D4 DO4 Y4		DVP data output port 4							
D5 DO5 Y5		DVP data output port 5							
D6 DO6 Y6		DVP data output port 6							
D7 DO7 Y7		DVP data output port 7							
D8 DO8 Y8		DVP data output port 8							
D9 DO9 Y9		DVP data output port 9							
D10 DO10 Y10		DVP data output port 10							
D11 DO11 Y11		DVP data output port 11							

[www.YDSCAM.com](http://www.YDSCAM.com) [sales@ydscam.com](mailto:sales@ydscam.com) Phone (WeChat, QQ): (+86) 177 2732 6718

All rights reserved @ YingDeShun Co. Ltd. Specifications subject to change without notice.

## Cameras Applications



### IMAGING DEVICES





## Camera Reliability Test

Reliability Inspection Item		Testing Method	Acceptance Criteria	
Category	Item			
Environmental	Storage Temperature	High 60°C 96 Hours	Temperature Chamber	No Abnormal Situation
		Low -20°C 96 Hours	Temperature Chamber	No Abnormal Situation
	Operation Temperature	High 60°C 24 Hours	Temperature Chamber	No Abnormal Situation
		Low -20°C 24 Hours	Temperature Chamber	No Abnormal Situation
	Humidity	60°C 80% 24 Hours	Temperature Chamber	No Abnormal Situation
	Thermal Shock	High 60°C 0.5 Hours Low -20°C 0.5 Hours Cycling in 24 Hours	Temperature Chamber	No Abnormal Situation
Physical	Drop Test (Free Falling)	Without Package 60cm	10 Times on Wood Floor	Electrically Functional
		With Package 60cm	10 Times on Wood Floor	Electrically Functional
	Vibration Test	50Hz X-Axis 2mm 30min	Vibration Table	Electrically Functional
		50Hz Y-Axis 2mm 30min	Vibration Table	Electrically Functional
		50Hz Z-Axis 2mm 30min	Vibration Table	Electrically Functional
	Cable Tensile Strength Test	Loading Weight 4 kg 60 Seconds Cycling in 24 Hours	Tensile Testing Machine	Electrically Functional
Electrical	ESD Test	Contact Discharge 2 KV	ESD Testing Machine	Electrically Functional
		Air Discharge 4 KV	ESD Testing Machine	Electrically Functional
	Aging Test	On/Off 30 Seconds Cycling in 24 Hours	Power Switch	Electrically Functional
	USB Connector	On/Off 250 Times	Plug and Unplug	Electrically Functional



## Camera Inspection Standard

Inspection Item		Inspection Method	Standard of Inspection		
Category	Item				
Appearance	FPC/ PCB	Color	The Naked Eye	Major Difference is Not Allowed.	
		Be Torn/Chopped	The Naked Eye	Copper Crack Exposure is Not Allowed.	
		Marking	The Naked Eye	Clear, Recognizable (Within 30cm Distance)	
	Holder	Scratches	The Naked Eye	The Inside Crack Exposure is Not Allowed	
		Gap	The Naked Eye	Meet the Height Standard	
		Screw	The Naked Eye	Make Sure Screws Are Presented (If Any)	
		Damage	The Naked Eye	The Inside Crack Exposure is Not Allowed	
	Lens	Scratch	The Naked Eye	No Effect On Resolution Standard	
		Contamination	The Naked Eye	No Effect On Resolution Standard	
		Oil Film	The Naked Eye	No Effect On Resolution Standard	
		Cover Tape	The Naked Eye	No Issue On Appearance.	
	Function	Image	No Communication	Test Board	Not Allowed
			Bright Pixel	Black Board	Not Allowed In the Image Center
Dark Pixel			White board	Not Allowed In the Image Center	
Blurry			The Naked Eye	Not Allowed	
No Image			The Naked Eye	Not Allowed	
Vertical Line			The Naked Eye	Not Allowed	
Horizontal Line			The Naked Eye	Not Allowed	
Light Leakage			The Naked Eye	Not Allowed	
Blinking Image			The Naked Eye	Not Allowed	
Bruise			Inspection Jig	Not Allowed	
Resolution			Chart	Follows Outgoing Inspection Chart Standard	
Color			The Naked Eye	No Issue	
Noise			The Naked Eye	Not Allowed	
Corner Dark			The Naked Eye	Less Than 100px By 100px	
Color Resolution			The Naked Eye	No Issue	
Dimension	Height	The Naked Eye	Follows Approval Data Sheet		
	Width	The Naked Eye	Follows Approval Data Sheet		
	Length	The Naked Eye	Follows Approval Data Sheet		
	Overall	The Naked Eye	Follows Approval Data Sheet		

## YDSCAM Package Solutions

YDS Camera Module



Complete with Lens Protection Film



Tray with Grid and Space



Place Cameras on the Tray

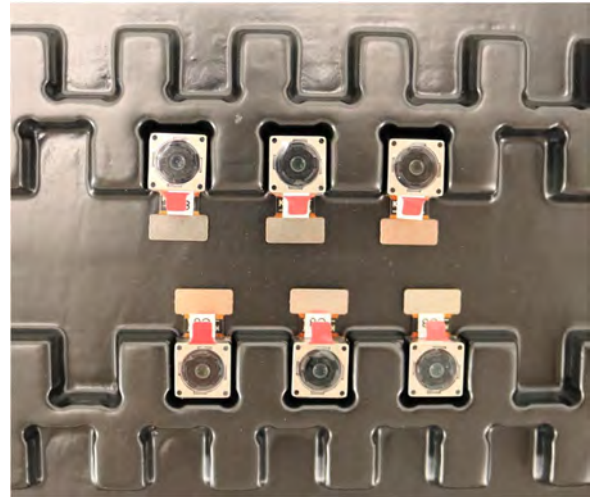



## YDSCAM Package Solutions

Full Tray of Cameras



Cover Tray with Lid



Place Tray into Anti-Static Bag



Vacuum the Anti-Static Bag



## YDSCAM Package Solutions

### Sealed Vacuum Anti-Static Bag with Labels

1. Model and Description 2. Quantity 3. Manufacturing Date Code 4. Caution





## YDSCAM Package Solutions

Place Foam Sheets Between Tray Bags



Foam Sheets are Larger Than Trays



Place Foam Sheets and Trays into Box



Foam Sheets are Tightly Fitting in Box



Seal the Carbon Box



Label the Carbon Shipping Box





## YDSCAM Package Solutions

USB Camera Module

Complete with Lens Protection Film

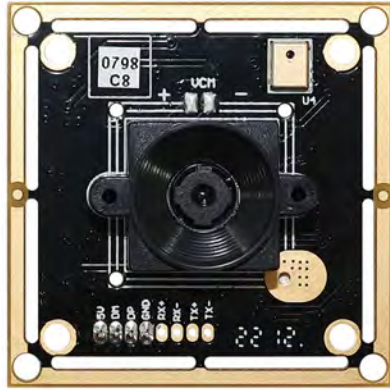

Place Camera Sample into Anti-Static Bag

Place USB Cameras into Tray



Seal the Tray with Anti-Static Bag

Label the Carbon Shipping Box





## YDSCAM Package Solutions

Place Camera Sample into Anti-Static Bag



Place Connectors into Anti-Static Bag



Label the Sample Bags



Place Connectors into Reel



Place Samples into the Carbon Box



Place Connectors into the Carbon Box





# YDS CAMERA MODULE

*your best camera partner*

## Company YDSCAM

YingDeShun Co. Ltd. (YDS) was established in 2017, a next-generation technology driven manufacturer specialized in research, design, and produce of audio and video products. YDS is occupying 20,000 square feet automated plants with 100 employees of annual throughput 30,000,000 units cameras.

YDS provides OEM, ODM design, contract manufacturing, and builds the camera products. You may provide the requirements to us, even with a hand draft, our sales and engineering work together to meet your needs. We consider ourselves your last-term partner in developing practical and innovative solutions.

Our team covers everything from initial concept development to mass produced product. YDS specializes in customized camera design, raw material, electronic engineering, firmware/software development, product testing, and packing design. Our experienced strategic supply systems offer a robust and dependable manufacturing capacity for orders of various sizes.

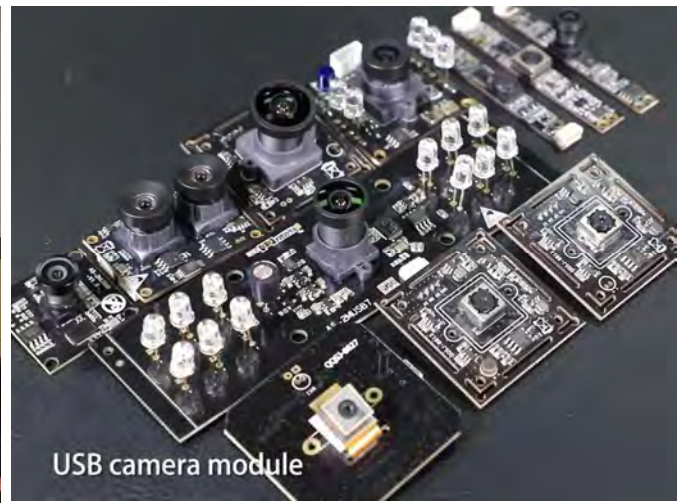

## Limited Warranty

YDS provides the following limited warranty if you purchased the Product(s) directly from YDS company or from YDS's website [www.YDSCAM.com](http://www.YDSCAM.com). Product(s) purchased from other sellers or sources are not covered by this Limited Warranty. YDS guarantees that the Product(s) will be free from defects in materials and workmanship under normal use for a period of one (1) year from the date you receive the product ("Warranty Period").

For all Product(s) that contain or develop material defects in materials or workmanship during the Warranty Period, YDS will, at its sole option, either: (i) repair the Product(s); (ii) replace the Product(s) with a new or refurbished Product(s) (replacement Product(s) being of identical model or functional equivalent); or (iii) provide you a refund of the price you paid for the Product(s).

This Limited Warranty of YDS is solely limited to repair and/or replacement on the terms set forth above. YDS is not reliable or responsible for any subsequent events.



[www.YDSCAM.com](http://www.YDSCAM.com) [sales@ydscam.com](mailto:sales@ydscam.com) Phone (WeChat, QQ): (+86) 177 2732 6718

All rights reserved @ YingDeShun Co. Ltd. Specifications subject to change without notice.





# YDS CAMERA MODULE

*your best camera partner*

## YDS Strength

### Powerful Factory



### Professional Service



### Promised Delivery



[www.YDSCAM.com](http://www.YDSCAM.com) [sales@ydscam.com](mailto:sales@ydscam.com) Phone (WeChat, QQ): (+86) 177 2732 6718

All rights reserved @ YingDeShun Co. Ltd. Specifications subject to change without notice.